

### General Description

The MIC4685 is a high-efficiency 200kHz stepdown (buck) switching regulator. Power conversion efficiency of above 85% is easily obtainable for a wide variety of applications. The MIC4685 achieves 3A of continuous current in the 7-pin SPAK package.

The thermal performance of the SPAK allows it to replace TO-220s and TO-263s (D<sup>2</sup>PAKs) in many applications. The SPAK saves board space with a 36% smaller footprint than TO-263.

High-efficiency is maintained over a wide output current range by utilizing a boost capacitor to increase the voltage available to saturate the internal power switch. As a result of this high-efficiency, only the ground plane of the PCB is needed for a heat sink.

The MIC4685 allows for a high degree of safety. It has a wide input voltage range of 4V to 30V (34V transient), allowing it to be used in applications where input voltage transients may be present. Built-in safety features include over-current protection, frequency-foldback short-circuit protection, and thermal shutdown.

The MIC4685 is available in a 7-pin SPAK package with a junction temperature range of -40°C to +125°C.

Data sheets and support documentation can be found on Micrel's web site at [www.micrel.com](http://www.micrel.com).

### Features

- Low 2mm profile SPAK package
- 3A continuous output current
- Wide 4V to 30V input voltage range (34V transient)
- Fixed 200kHz PWM operation
- Over 85% efficiency
- Output voltage adjustable to 1.235V
- All surface mount solution
- Internally compensated with fast transient response
- Over-current protection
- Frequency foldback short-circuit protection
- Thermal shutdown

### Applications

- Point-of-load power supplies
- Simple high-efficiency step-down regulators
- 5V to 3.3V/2A conversion
- 12V to 5V/3.3V/2.5V/1.8V 3A conversion
- Dual-output ±5V conversion
- Base stations
- LCD power supplies
- Battery chargers

### Typical Application

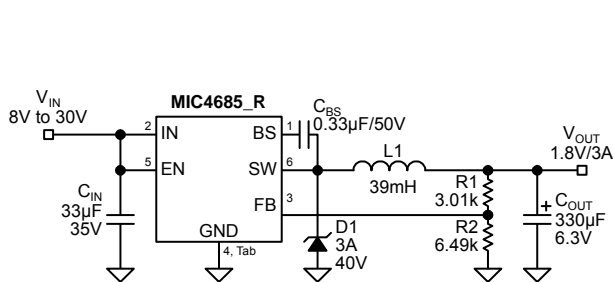

1.8V Output Converter

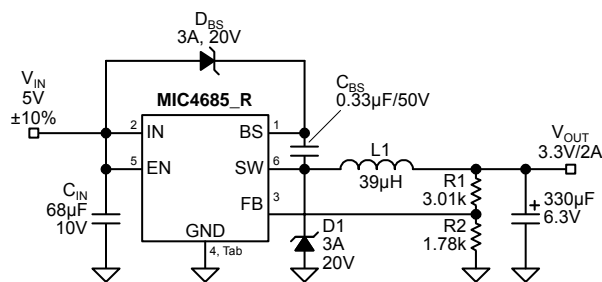

5V to 3.3V Converter

SuperSwitcher is a trademark of Micrel, Inc

## Ordering Information

Part Number		Voltage	Junction Temp. Range	Package
Standard	RoHS Compliant*			
MIC4685BR	MIC4685WR	Adj.	-40° to +125°C	7-Pin SPAK
	MIC4685WR EV	Adj.		Evaluation Board

\* RoHS compliant with 'high-melting solder' exemption.

## Pin Configuration

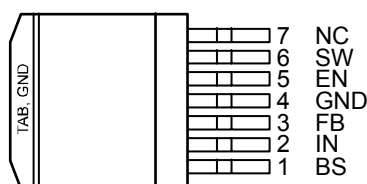

7-Pin SPAK (R)

## Pin Description

Pin Number	Pin Name	Pin Function
1	BS	Bootstrap Voltage Node (External Component): Connect to external boost capacitor.
2	IN	Supply (Input): Unregulated +4V to 30V supply voltage (34V transient)
3	FB	Feedback (Input): Outback voltage feedback to regulator. Connect to 1.235V tap of resistive divider.
4, Tab	GND	Ground
5	EN	Enable (Input): Logic high = enable; logic low = shutdown
6	SW	Switch (Output): Emitter of NPN output switch. Connect to external storage inductor and Schottky diode.
7	NC	No Connect. Tie this pin-to-ground.

## Detailed Pin Description

### Switch (SW, Pin 6)

The switch pin is tied to the emitter of the main internal NPN transistor. This pin is biased up to the input voltage, minus the  $V_{SAT}$ , of the main NPN pass element. The emitter is also driven negative when the output inductor's magnetic field collapses at turn-off. During the OFF time, the SW pin is clamped by the output Schottky diode typically to a  $-0.5V$ .

### Ground (GND, Pin 4, Tab)

There are two main areas of concern when it comes to the ground pin, EMI and ground current. In a buck regulator or any other non-isolated switching regulator, the output capacitor(s) and diode(s) ground is referenced back to the switching regulator's or controller's ground pin. Any resistance between these reference points causes an offset voltage/IR drop proportional to load current and poor load regulation. This is why it's important to keep the output grounds placed as close as possible to the switching regulator's ground pin. To keep radiated EMI to a minimum, it is necessary to place the input capacitor ground lead as close as possible to the switching regulator's ground pin.

### Input Voltage ( $V_{IN}$ , Pin 2)

The  $V_{IN}$  pin is the collector of the main NPN pass element. This pin is also connected to the internal regulator. The output diode or clamping diode should have its cathode as close as possible to this point to avoid voltage spikes adding to the voltage across the collector.

### Bootstrap (BS, Pin 1)

The bootstrap pin, in conjunction with the external bootstrap capacitor, provides a bias voltage higher than the input voltage to the MIC4685's main NPN pass element. The bootstrap capacitor sees the  $dv/dt$  of the switching action at the SW pin as an AC voltage. The bootstrap capacitor then couples the AC voltage back to the BS pin, plus the dc offset of  $V_{IN}$  where it is rectified and used to provide additional drive to the main switch; in this case, a NPN transistor.

This additional drive reduces the NPN's saturation voltage and increases efficiency, from a  $V_{SAT}$  of 1.8V, and 75% efficiency to a  $V_{SAT}$  of 0.5V and 88% efficiency respectively.

### Feedback (FB, Pin 3)

The feedback pin is tied to the inverting side of an error amplifier. The noninverting side is tied to a 1.235V bandgap reference. An external resistor voltage divider is required from the output-to-ground, with the center tied to the feedback pin. See Tables 1 and 2 for recommended resistor values.

### Enable (EN, Pin 5)

The enable (EN) input is used to turn on the regulator and is TTL compatible. Note: connect the enable pin to the input if unused. A logic-high enables the regulator. A logic-low shuts down the regulator and reduces the stand-by quiescent input current to typically  $150\mu A$ . The enable pin has an up-per threshold of 2.0V minimum and lower threshold of 0.8V maximum. The hysteresis provided by the upper and lower thresholds acts as an UVLO and prevents unwanted turn on of the regulator due to noise.

**Absolute Maximum Ratings<sup>(1)</sup>**

Supply Voltage ( $V_{IN}$ ) <sup>(1)</sup> .....	+34V
Enable Voltage ( $V_{EN}$ ).....	-0.3V to $V_{IN}$
Steady-State Output Switch Voltage ( $V_{SW}$ ).....	-1V to $V_{IN}$
Feedback Voltage ( $V_{FB}$ ) .....	+12V
Storage Temperature ( $T_s$ ).....	-65°C to +150°C
EDS Rating <sup>(3)</sup> .....	2kV

**Operating Ratings<sup>(2)</sup>**

Supply Voltage ( $V_{IN}$ ) <sup>(4)</sup> .....	+4V to +30V
Junction Temperature ( $T_J$ ) .....	-40°C to +125°C
Package Thermal Resistance	
SPAK-7 ( $\theta_{JA}$ ).....	11.8°C/W
SPAK-7 ( $\theta_{JC}$ ).....	2.2°C/W

**Electrical Characteristics**

$V_{IN} = V_{EN} = 12V$ ;  $V_{OUT} = 5V$ ;  $I_{OUT} = 500mA$ ;  $T_A = 25^\circ C$ , **bold** values indicate  $-40^\circ C \leq T_J \leq +125^\circ C$ , unless noted.

Parameter	Condition	Min	Typ	Max	Units
<b>MIC4685 [Adjustable]</b>					
Feedback Voltage	( $\pm 2\%$ )	1.210	1.235	1.260	V
	( $\pm 3\%$ )	<b>1.198</b>		<b>1.272</b>	V
	$8V \leq V_{IN} \leq 30V$ , $0.1A \leq I_{LOAD} \leq 1A$ , $V_{OUT} = 5V$ , <b>Note 4</b>	1.186	1.235	1.284	V
		<b>1.173</b>		<b>1.297</b>	V
Feedback Bias Current			50		nA
Maximum Duty Cycle	$V_{FB} = 1.0V$		94		%
Output Leakage Current	$V_{IN} = 30V$ , $V_{EN} = 0V$ , $V_{SW} = 0V$		5	500	$\mu A$
	$V_{IN} = 30V$ , $V_{EN} = 0V$ , $V_{SW} = 1V$		1.4	20	mA
Quiescent Current	$V_{FB} = 1.5V$		6	12	mA
Bootstrap Drive Current	$V_{FB} = 1.5V$ , $V_{SW} = 0V$	250	380		mA
Bootstrap Voltage	$I_{BS} = 10mA$ , $V_{FB} = 1.5V$ , $V_{SW} = 0V$	5.5	6.2		V
Frequency Fold Back	$V_{FB} = 0V$	30	70	120	kHz
Oscillator Frequency		180	200	225	kHz
Saturation Voltage	$I_{OUT} = 1A$		0.59		V
Short Circuit Current Limit	$V_{FB} = 0V$ , <i>See Test Circuit</i>	3.5		6	A
Shutdown Current	$V_{EN} = 0V$		150	200	$\mu A$
Enable Input Logic Level	regulator on	2			V
	regulator off			0.8	V
Enable Pin Input Current	$V_{EN} = 0V$ (regulator off)		16	50	$\mu A$
	$V_{EN} = 0V$ (regulator on)	-1	-0.83		mA
Thermal Shutdown @ $T_J$			160		°C

**Notes:**

- Exceeding the absolute maximum rating may damage the device.
- The device is not guaranteed to function outside its operating rating.
- Devices are ESD sensitive. Handling precautions recommended. Human body model, 1.5k $\Omega$  in series with 100pF.
- 2.5V of headroom is required between  $V_{IN}$  and  $V_{OUT}$ . The headroom can be reduced by implementing a bootstrap diode as seen on the 5V to 3.3V circuit on page 1.

## Test Circuit

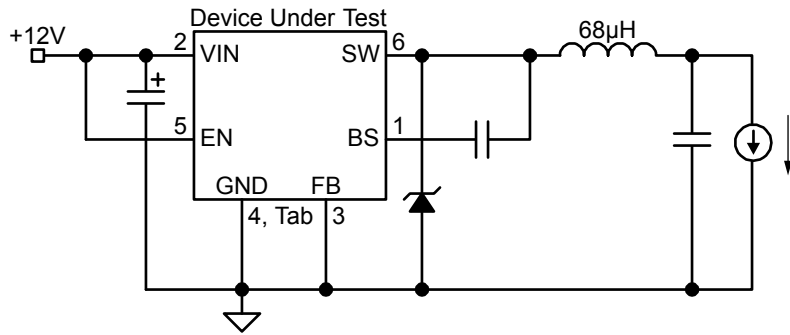

Current Limit Test Circuit

## Shutdown Input Behavior

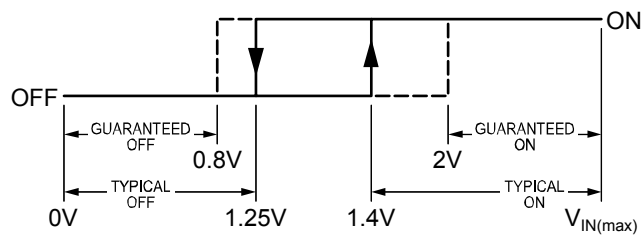

Enable Hysteresis

# Typical Characteristics

(TA = 25°C unless otherwise noted)

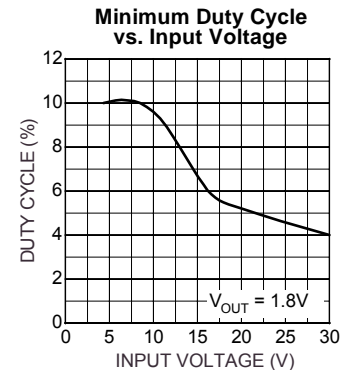
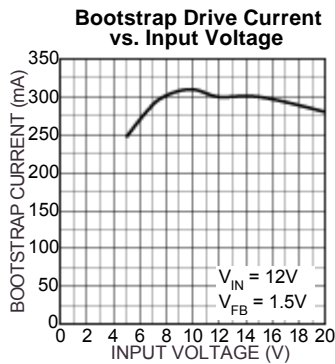
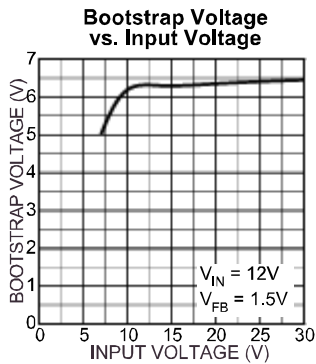
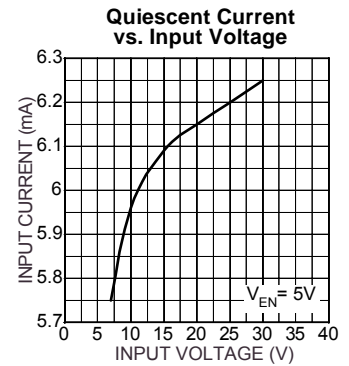
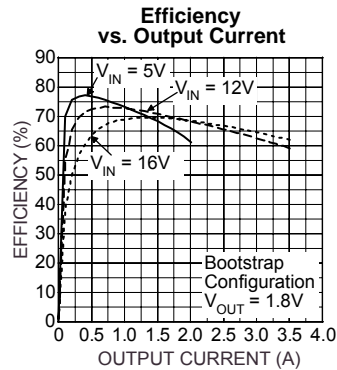
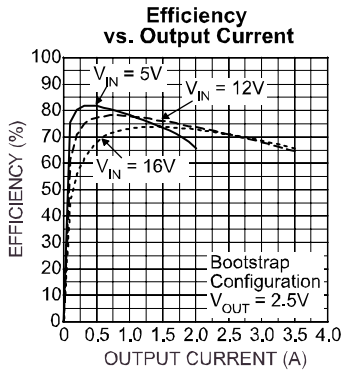
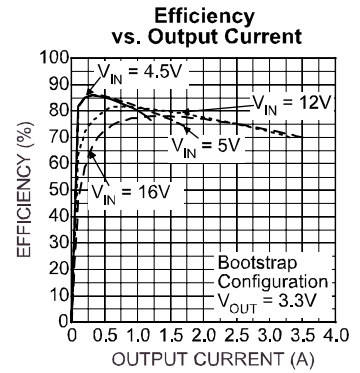
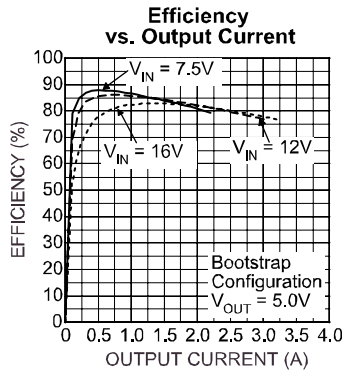
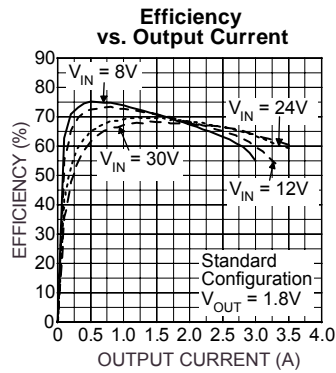
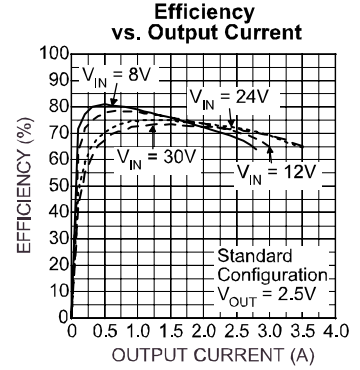
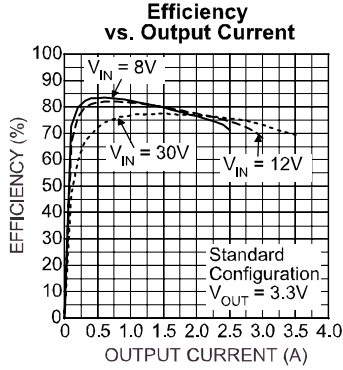
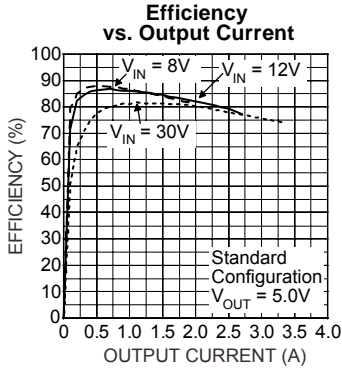

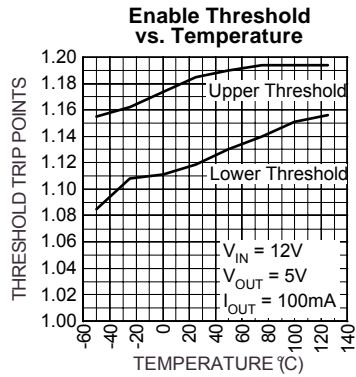
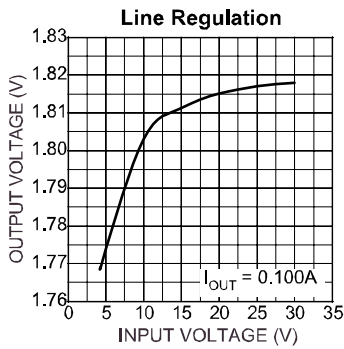
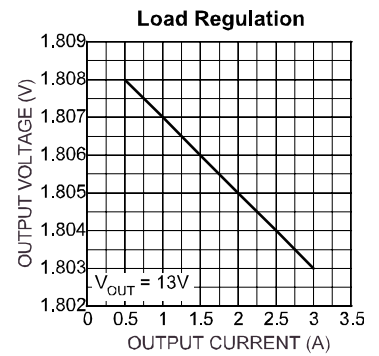
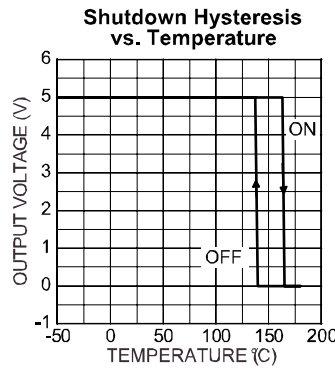
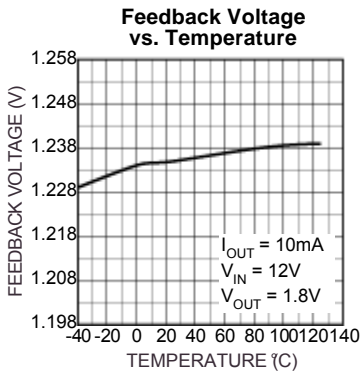
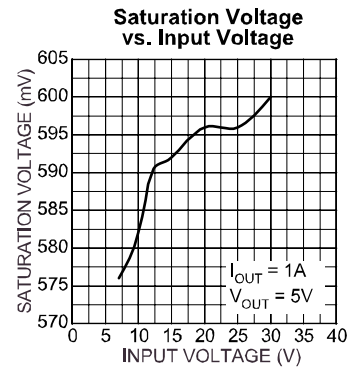
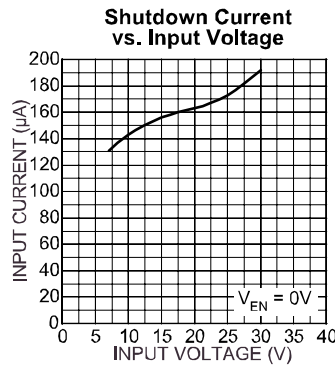
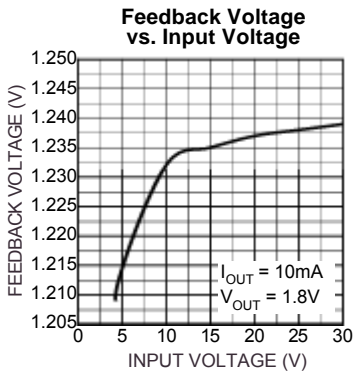

# Typical Safe Operating Area (SOA)

(SOA measured on the MIC4685 Evaluation Board\*)

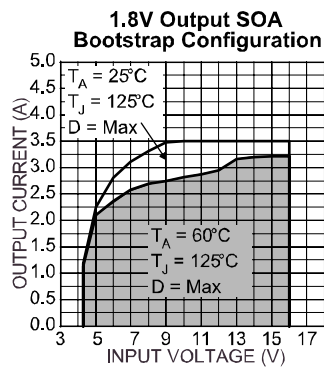
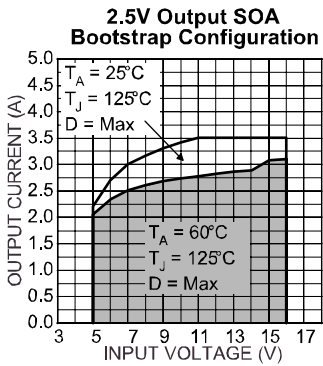
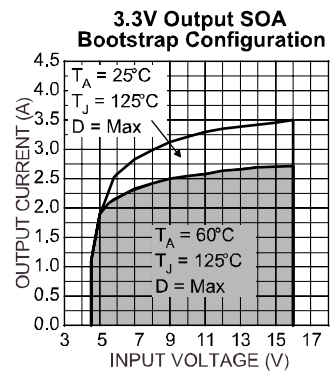
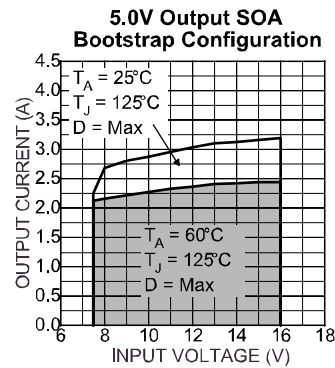
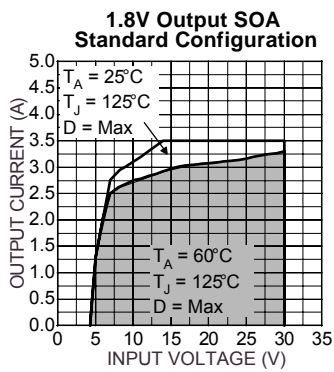
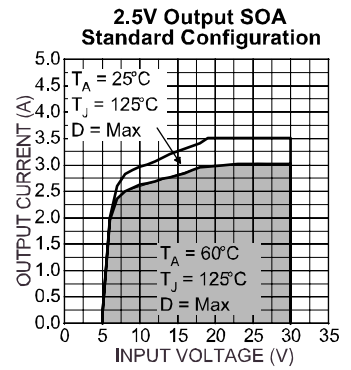
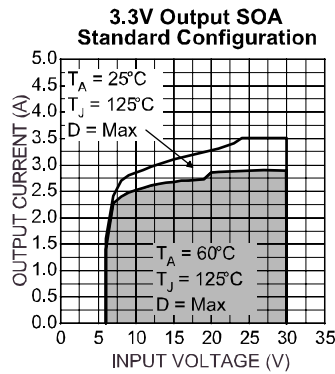
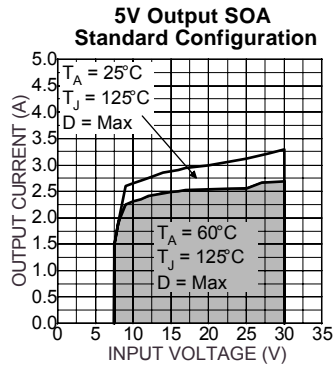

\*  $I_{OUT} < 3A$ , D1: Diode Inc. B340 (3A/40V)  
 $I_{OUT} < 3A$ , D1: SBM1040 (10A/40V)



## Functional Characteristics

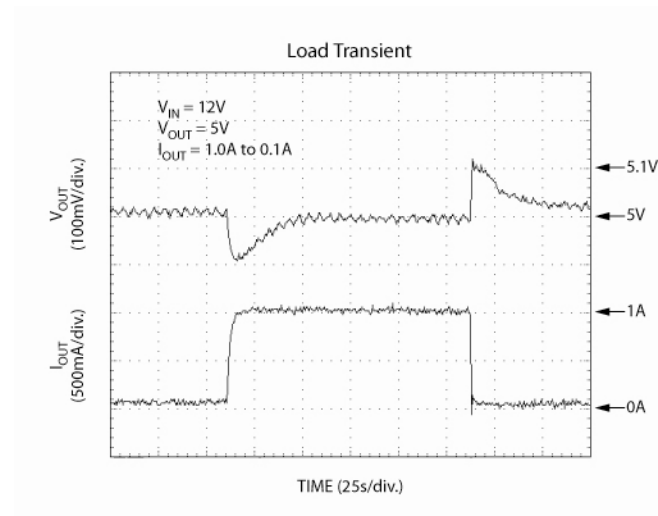
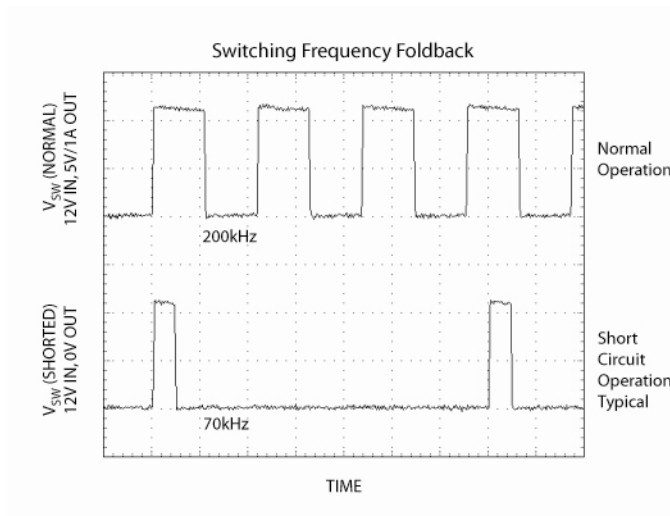

### Frequency Foldback

The MIC4685 folds the switching frequency back during a hard short circuit condition to reduce the energy per cycle and protect the device.

## Functional Diagram

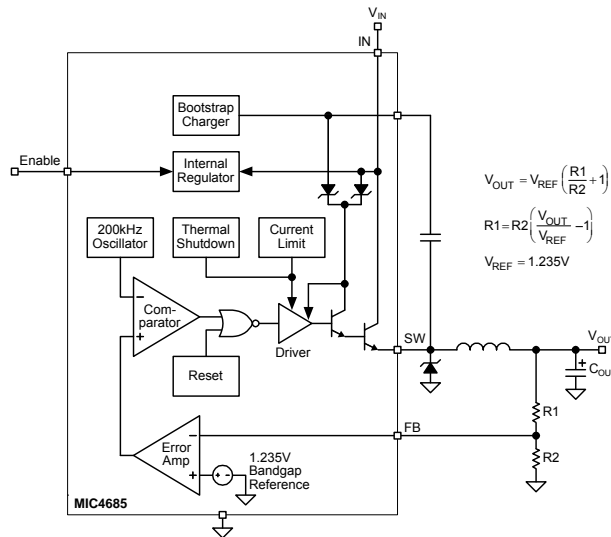

Figure 1. Adjustable Regulator

## Functional Description

The MIC4685 is a variable duty cycle switch-mode regulator with an internal power switch. Refer to the above block diagram.

### Supply Voltage

The MIC4685 operates from a +4V to +30V (34V transient) unregulated input. Highest efficiency operation is from a supply voltage around +12V. See the efficiency curves in the "Typical Characteristics" section on page 5.

### Enable/Shutdown

The enable (EN) input is TTL compatible. Tie the input high if unused. A logic-high enables the regulator. A logic-low shuts down the internal regulator which reduces the current to typically 150µA when  $V_{EN} = 0V$ .

### Feedback

In the adjustable version, an external resistive voltage divider is required from the output voltage to ground, center tapped to the FB pin. See Table 1 and Table 2 for recommended resistor values.

### Duty Cycle Control

A fixed-gain error amplifier compares the feedback signal with a 1.235V bandgap voltage reference. The resulting error amplifier output voltage is compared to a 200kHz sawtooth waveform to produce a voltage controlled variable duty cycle output.

A higher feedback voltage increases the error amplifier output voltage. A higher error amplifier voltage (comparator inverting input) causes the comparator to detect only the peaks of the sawtooth, reducing the duty cycle of the comparator output. A lower feedback voltage increases the duty cycle. The MIC4685 uses a voltage-mode control architecture.

### Output Switching

When the internal switch is ON, an increasing current flows from the supply  $V_{IN}$ , through external storage inductor  $L1$ , to output capacitor  $C_{OUT}$  and the load. Energy is stored in the inductor as the current increases with time.

When the internal switch is turned OFF, the collapse of the magnetic field in  $L1$  forces current to flow through fast recovery diode  $D1$ , charging  $C_{OUT}$ .

### Output Capacitor

External output capacitor  $C_{OUT}$  provides stabilization and reduces ripple.

### Return Paths

During the ON portion of the cycle, the output capacitor and load currents return to the supply ground. During the OFF portion of the cycle, current is being supplied to the output capacitor and load by storage inductor  $L1$ , which means that  $D1$  is part of the high-current return path.

## Application Information

### Adjustable Regulators

Adjustable regulators require a 1.235V feedback signal. Recommended voltage-divider resistor values for common output voltages are detailed in Table 1.

For other voltages, the resistor values can be determined using the following formulas:

$$V_{OUT} = V_{REF} \left( \frac{R1}{R2} + 1 \right)$$

$$R1 = R2 \left( \frac{V_{OUT}}{V_{REF}} - 1 \right)$$

$$V_{REF} = 1.235V$$

### Thermal Considerations

The MIC4685 is capable of high current due to the thermally optimized SPAK package.

One limitation of the maximum output current on any MIC4685 design is the junction-to-ambient thermal resistance ( $\theta_{JA}$ ) of the design (package and ground plane).

Examining  $\theta_{JA}$  in more detail:

$$\theta_{JA} = (\theta_{JC} + \theta_{CA})$$

where:

$\theta_{JC}$  = junction-to-case thermal resistance

$\theta_{CA}$  = case-to-ambient thermal resistance

$\theta_{JC}$  is a relatively constant 2.2°C/W for a 7-pin SPAK.

$\theta_{CA}$  is dependent upon layout and is primarily governed by the connection of pins 4, and Tab to the ground plane. The purpose of the ground plane is to function as a heat sink.

### Checking the Maximum Junction Temperature:

For this example, with an output power ( $P_{OUT}$ ) of 7.5W, (5V output at 1.5A with  $V_{IN} = 12V$ ) and 60°C maximum ambient temperature, what is the junction temperature?

Referring to the "Typical Characteristics: 5V Output Efficiency" graph, read the efficiency ( $\eta$ ) for 1.5A output current at  $V_{IN} = 12V$  or perform your own measurement.

$$\eta = 84\%$$

The efficiency is used to determine how much of the output power ( $P_{OUT}$ ) is dissipated in the regulator circuit ( $P_D$ ).

$$P_D = \frac{P_{OUT}}{\eta} - P_{OUT}$$

$$P_D = \frac{7.5W}{0.84} - 7.5W$$

$$P_D = 1.43W$$

A worst-case rule of thumb is to assume that 80% of the total output power dissipation is in the MIC4685 ( $P_{D(IC)}$ ) and 20% is in the diode-inductor-capacitor circuit.

$$P_{D(IC)} = 0.8 P_D$$

$$P_{D(IC)} = 0.8 \times 1.43W$$

$$P_{D(IC)} = 1.14W$$

Calculate the worst-case junction temperature:

$$T_J = P_{D(IC)} \theta_{JC} + (T_C - T_A) + T_{A(max)}$$

where:

$T_J$  = MIC4685 junction temperature

$P_{D(IC)}$  = MIC4685 power dissipation

$\theta_{JC}$  = junction-to-case thermal resistance.

The  $\theta_{JC}$  for the MIC4685's 7-pin SPAK is approximately 2.2°C/W.

$T_C$  = "pin" temperature measurement taken at the Tab.

$T_A$  = ambient temperature

$T_{A(max)}$  = maximum ambient operating temperature for the specific design.

Calculating the maximum junction temperature given a maximum ambient temperature of 60°C:

$$T_J = 1.14 \times 2.2^\circ C + (46^\circ C - 25^\circ C) + 60^\circ C$$

$$T_J = 83.5^\circ C$$

This value is within the allowable maximum operating junction temperature of 125°C as listed in "Operating Ratings." Typical thermal shutdown is 160°C and is listed in "Electrical Characteristics." Also refer to the "Typical Safe Operating Area (SOA)" graphs in this document.

## Layout Considerations

Layout is very important when designing any switching regulator. Rapidly changing currents, through the printed circuit board traces and stray inductance, can generate voltage transients which can cause problems.

To minimize stray inductance and ground loops, keep trace lengths as short as possible. For example, keep D1 close to pin 6 and pin 4, and Tab, keep L1 away from sensitive node FB, and keep  $C_{IN}$  close to pin 2 and pin 4, and Tab. See “*Applications Information: Thermal Considerations*” for ground plane layout.

The feedback pin should be kept as far way from the switching elements (usually L1 and D1) as possible.

A circuit with sample layouts are provided. See Figure 6. Gerber files are available upon request.

## Bootstrap Diode

The bootstrap diode provides an external bias source directly to the main pass element, this reduces  $V_{SAT}$  thus allowing the MIC4685 to be used in very low head-room applications i.e.,  $5V_{IN}$  to  $3.3V_{OUT}$  with high efficiencies. Bootstrap diode not for use if  $V_{IN}$  exceeds  $16V$ ,  $V_{IN}$ . See Figure 2.

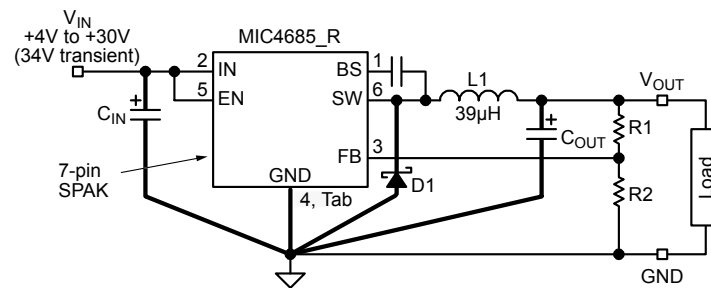

Figure 2. Critical Traces for Layout

## Recommended Components for a Given Output Voltage (Bootstrap Configuration)

V <sub>OUT</sub>	I <sub>OUT</sub> *	R1	R2	V <sub>IN</sub>	C1	D1	D2	L1	C4
5.0V	2.1A	3.01k	976Ω	7.5V – 16V	47μF, 20V Vishay-Dale 595D476X0020D2T	3A, 30V Schottky + Vishay B330A	1A, 20V Schottky B120-E3	39μH Sumida CDRH127R-390MC	330μF, 6.3V Vishay-Dale 594D337X06R3D2T
3.3V	2.2A	3.01k	1.78k	6.0V – 16V	47μF, 20V Vishay-Dale 595D476X0020D2T	3A, 30V Schottky B330A	1A, 20V Schottky B120-E3	39μH Sumida CDRH127R-390MC	330μF, 6.3V Vishay-Dale 594D337X06R3D2T
2.5V	2.0A	3.01k	2.94k	5.0V – 16V	47μF, 20V Vishay-Dale 595D476X0020D2T	3A, 30V Schottky B330A	1A, 20V Schottky B120-E3	39μH Sumida CDRH127R-390MC	330μF, 6.3V Vishay-Dale 594D337X06R3D2T
1.8V	2.0A	3.01k	6.49k	5.0V – 16V	47μF, 20V Vishay-Dale 595D476X0020D2T	3A, 30V Schottky + Vishay B330A	1A, 20V Schottky B120-E3	39μH Sumida CDRH127R-390MC	330μF, 6.3V Vishay-Dale 594D337X06R3D2T

\* Maximum output current at minimum input voltage. See SOA curves for maximum output current vs. Input voltage.

**Table 1. Recommended Components for Common Output Voltages**

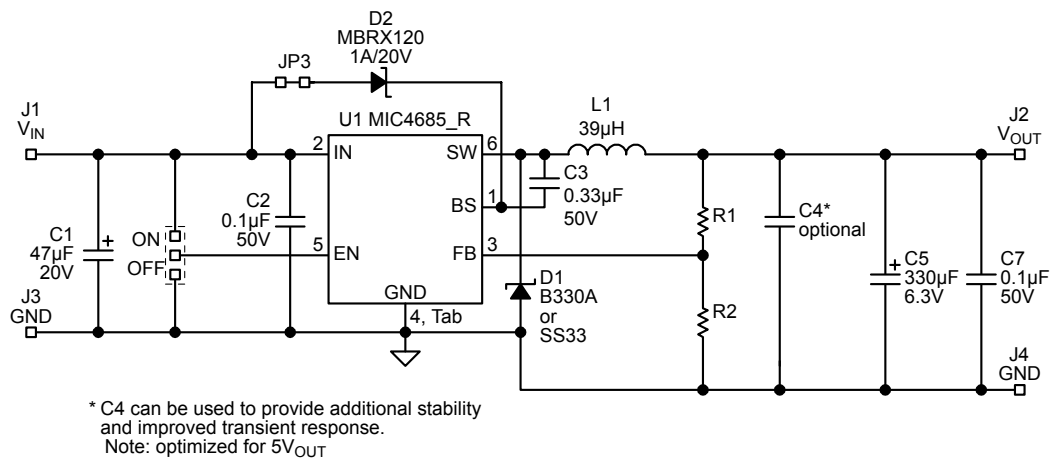

**Figure 3. Schematic Diagram**

## Recommended Components for a Given Output Voltage (Standard Configuration)

V <sub>OUT</sub>	I <sub>OUT</sub> *	R1	R2	V <sub>IN</sub>	C1	D1	L1	C5
5.0V	2.0A	3.01k	976Ω	8V – 30V	33μF, 35V Vishay-Dale 595D336X0035R2T	3A, 40V Schottky B340A-E3	39μH Sumida CDRH127-390MC	330μF, 6.3V Vishay-Dale 594D337X06R3D2T
3.3V	2.4A	3.01k	1.78k	8V – 26V	33μF, 35V Vishay-Dale 595D336X0035R2T	3A, 40V Schottky B340A-E3	39μH Sumida CDRH127-390MC	330μF, 6.3V Vishay-Dale 594D337X06R3D2T
2.5V	2.35A	3.01k	2.94k	7V – 23V	33μF, 35V Vishay-Dale 595D336X0035R2T	3A, 40V Schottky B340A-E3	39μH Sumida CDRH127-390MC	330μF, 6.3V Vishay-Dale 594D337X06R3D2T
1.8V	2.0A	3.01k	6.49k	6V – 16V	33μF, 35V Vishay-Dale 595D336X0035R2T	3A, 40V Schottky + Vishay B340A-E3	39μH Sumida CDRH127-390MC	330μF, 6.3V Vishay-Dale 594D337X06R3D2T

\* Maximum output current at minimum input voltage. See SOA curves for maximum output current vs. Input voltage.

**Table 2. Recommended Components for Common Output Voltages**

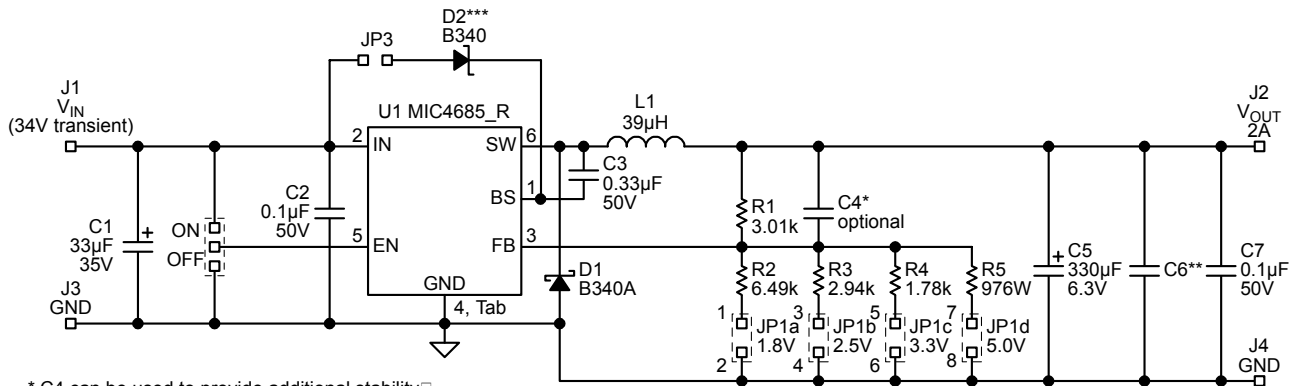

\* C4 can be used to provide additional stability and improved transient response.  
 Note: optimized for 5V<sub>OUT</sub>  
 \*\* C6 Optional  
 \*\*\* D2 is not used for standard configuration and JP3 is open.

**Figure 4. Evaluation Board Schematic Diagram**

Printed Circuit Board

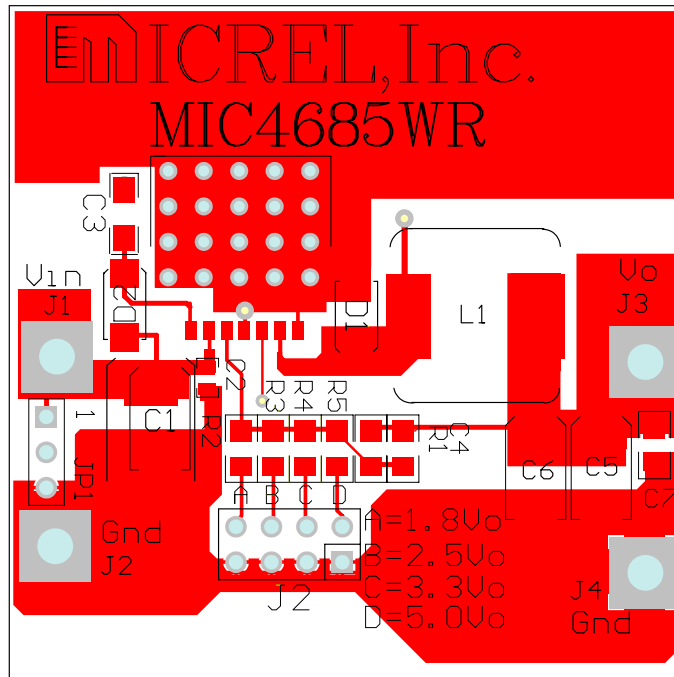

Figure 5a. Top Layer

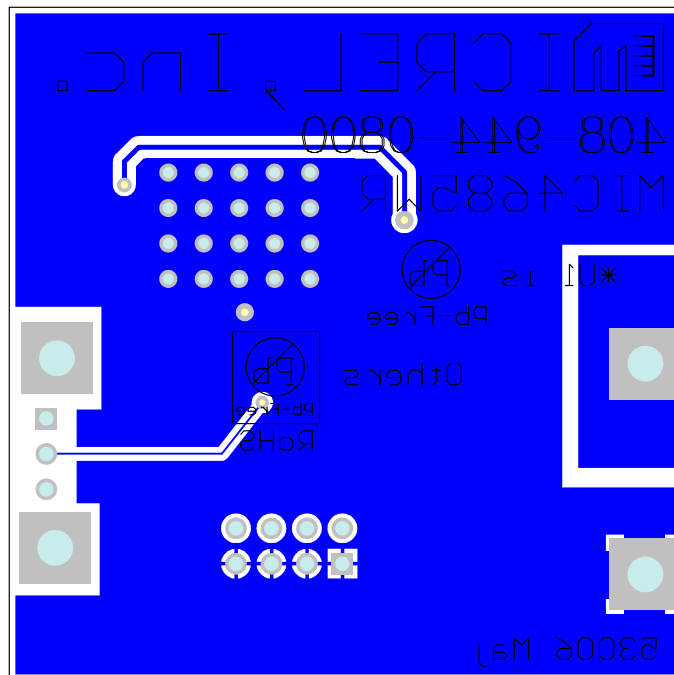

Figure 5b. Bottom Layer

**Abbreviated Bill of Materials (Critical Components)**

Item	Part Number	Manufacturer	Description	Qty.
C1	594D336X0035R2T	Vishay Sprague <sup>(1)</sup>	33 $\mu$ F 35V	1
C2, C7	VJ0805Y104KXAAB	Vitramon	0.1 $\mu$ F 50V	2
C3	GRM426X7R334K50	Murata <sup>(5)</sup>	0.33 $\mu$ F, 50V ceramic capacitor	
	VJ1206Y334KXAAT	Vishay <sup>(1)</sup>	0.33 $\mu$ F, 50V ceramic capacitor	
C4*	Optional		1800pF, 50V ceramic	1
C5	594D337X06R3D2T	Vishay Sprague <sup>(1)</sup>	330 $\mu$ F, 6.3V, tantalum	1
D1	B340A	Diode Inc <sup>(2)</sup>	Schottky 3A 40V	1
	B340LA-EA	Vishay <sup>(1)</sup>	Schottky 3A 40V	1
	SSA34A	Vishay <sup>(1)</sup>	Schottky 3A 40V	1
	B340A	Vishay <sup>(1)</sup>	Schottky 3A 40V	1
D2	B120-EA	Vishay <sup>(1)</sup>	Schottky 3A 40V	1
	B340A	Diode Inc <sup>(2)</sup>	Schottky 3A 40V	1
	MBRX120	Micro Commercial Component <sup>(4)</sup>	Schottky 1A 20V	
L1	CDRH127-390MC	Sumida <sup>(3)</sup>	39 $\mu$ H	1
R1	CRCW08053011FKEY3	Vishay <sup>(1)</sup>	3K01, 1%, 1/10W, 805	1
R2	CRCW08056491FKEY3	Vishay <sup>(1)</sup>	6K49, 1%, 1/10W, 805	1
R3	CRCW08052941FKEY3	Vishay <sup>(1)</sup>	2K94, 1%, 1/10W, 805	1
R4	CRCW08051781FKEY3	Vishay <sup>(1)</sup>	1K78, 1%, 1/10W, 805	1
R5	CRCW08051781FKEY3	Vishay <sup>(1)</sup>	976 $\Omega$ , 1%, 1/10W, 805	1
<b>U1</b>	<b>MIC4685BR/WR</b>	<b>Micrel, Inc.<sup>(6)</sup></b>	<b>3A 200kHz SPAK Buck Regulator</b>	<b>1</b>

**Notes:**

1. Vishay Sprague, Inc.: [www.vishay.com](http://www.vishay.com)
2. Diodes Inc.: [www.diodes.com](http://www.diodes.com)
3. Sumida: [www.sumida.com](http://www.sumida.com)
4. Micro Commercial Component: [www.mccsemi.com](http://www.mccsemi.com)
5. Murata: [www.murata.com](http://www.murata.com)
6. **Micrel, Inc.: [www.website.com](http://www.website.com)**



### Package Information

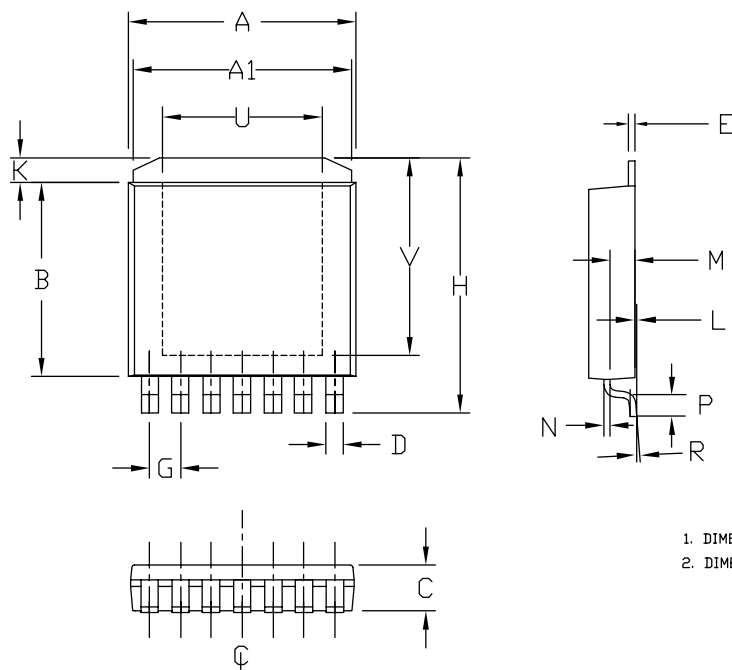

	INCHES		MILLIMETERS	
A	0.365	0.375	9.27	9.52
A1	0.350	0.360	8.89	9.14
B	0.310	0.320	7.87	8.13
C	0.070	0.080	1.78	2.03
D	0.025	0.031	0.63	0.79
E	0.010	BSC	0.25	BSC
G	0.050	BSC	1.27	BSC
H	0.410	0.420	10.41	10.67
K	0.030	0.050	0.76	1.27
L	0.001	0.005	0.03	0.13
M	0.035	0.045	0.89	1.14
N	0.010	BSC	0.25	BSC
P	0.031	0.041	0.79	1.04
R	0°	6°	0°	6°
U	0.256	BSC	6.50	BSC
V	0.316	BSC	8.03	BSC

1. DIMENSION DOES NOT INCLUDE MOLD FLASH OR PROTRUSIONS.
2. DIMENSION INCLUDES PLATING THICKNESS.

### 7-SPAK (R)

**MICREL, INC. 2180 FORTUNE DRIVE SAN JOSE, CA 95131 USA**  
 TEL +1 (408) 944-0800 FAX +1 (408) 474-1000 WEB <http://www.micrel.com>

The information furnished by Micrel in this data sheet is believed to be accurate and reliable. However, no responsibility is assumed by Micrel for its use. Micrel reserves the right to change circuitry and specifications at any time without notification to the customer.

Micrel Products are not designed or authorized for use as components in life support appliances, devices or systems where malfunction of a product can reasonably be expected to result in personal injury. Life support devices or systems are devices or systems that (a) are intended for surgical implant into the body or (b) support or sustain life, and whose failure to perform can be reasonably expected to result in a significant injury to the user. A Purchaser's use or sale of Micrel Products for use in life support appliances, devices or systems is a Purchaser's own risk and Purchaser agrees to fully indemnify Micrel for any damages resulting from such use or sale.

© 2004 Micrel, Incorporated.